

2021年05月25日  
多摩川エアロシステムズ株式会社

## ワクチン接種会場や各種イベントなど、多用途で使用可能 多摩川エアロシステムズが、カナダ国Robus社製 「移動式シェルター」の輸入販売業務を開始

多摩川エアロシステムズ株式会社(東京都大田区)は、カナダ国Robus社の国内販売代理店として、「移動式シェルター」の販売業務を5月1日より開始しました。同社製シェルターは、設置時間が僅か約10分と迅速に展開することが可能で、新型コロナウイルス対応も含めた衛生設備用として利用することもできる画期的なシステムです。



エアポート除染ゲートとの併用例

### ▼製品資料(PDF)

<https://robusinc.com/wp-content/uploads/2019/10/ROBUS-COMMERCIAL-E-CATALOGUE.pdf>

トレーラー式コンテナ内に収容されたシェルターは、自由に移動してどこでも展開することができます。折り畳み式ルーフビームは、頑丈な軽量フレームで構成され、風速120kmまで対応可能です。生地部分は、耐火性、抗真菌性、耐熱性、耐寒性、耐水性、耐UV性を有する特殊ファブリック素材を採用しています。

また、シェルター内を陰圧システムにより、内部の空気をHEPAフィルターにより外部へ排気することも可能で、除染用サニタリーゲートとの組み合わせにより、感染者隔離用にも対応が可能です。

仕様は、用途に合わせて、内部の隔壁や窓、ドアなど様々なカスタマイズが可能で、ワクチン接種会場などの医療用、災害援助用、各種イベント、航空機用格納庫など多目的な利用に応えられるオプション品が準備されています。



建物前設置例



医療現場活用例



イベント活用例

多摩川エアロシステムズ株式会社は、保守、修理等のアフターサービス体制を構築し、国内市場を開拓していく予定です。

#### ■会社概要

商号 : 多摩川エアロシステムズ株式会社

代表者 : 中島 啓介

所在地 : 東京都大田区羽田空港1丁目7番1号 空港施設第二総合ビル2F

設立 : 1952年11月

- 事業内容 : ・航空機電装品の整備  
・航空機用地上電源装置の製造販売整備  
・航空機用機器の輸入販売・整備  
・航空機整備補助(ドックメンテナンス補助)

URL : <http://www.tamagawa-as.jp/>

■本リリースに関するお問い合わせ先  
多摩川エアロシステムズ株式会社  
営業開発部 企画グループ：田口、早川  
TEL : 03-5708-7288  
FAX : 03-5708-0898  
Email : sales@tamagawa-as.jp  
Website : <http://www.tamagawa-as.jp/>

## プレスリリース画像



エアポート除染ゲートとの併用例



トーイングカー



側面図／上面図



建物前設置例



医療現場活用例



イベント活用例

添付動画

The Robus Shelter Teaser  
<https://www.youtube.com/embed/dYp7yg2Oe5A>



# ROBUS

## SHELTERS

ROBUS SHELTER SYSTEM-20M  
FOR BLACKHAWK HELICOPTER

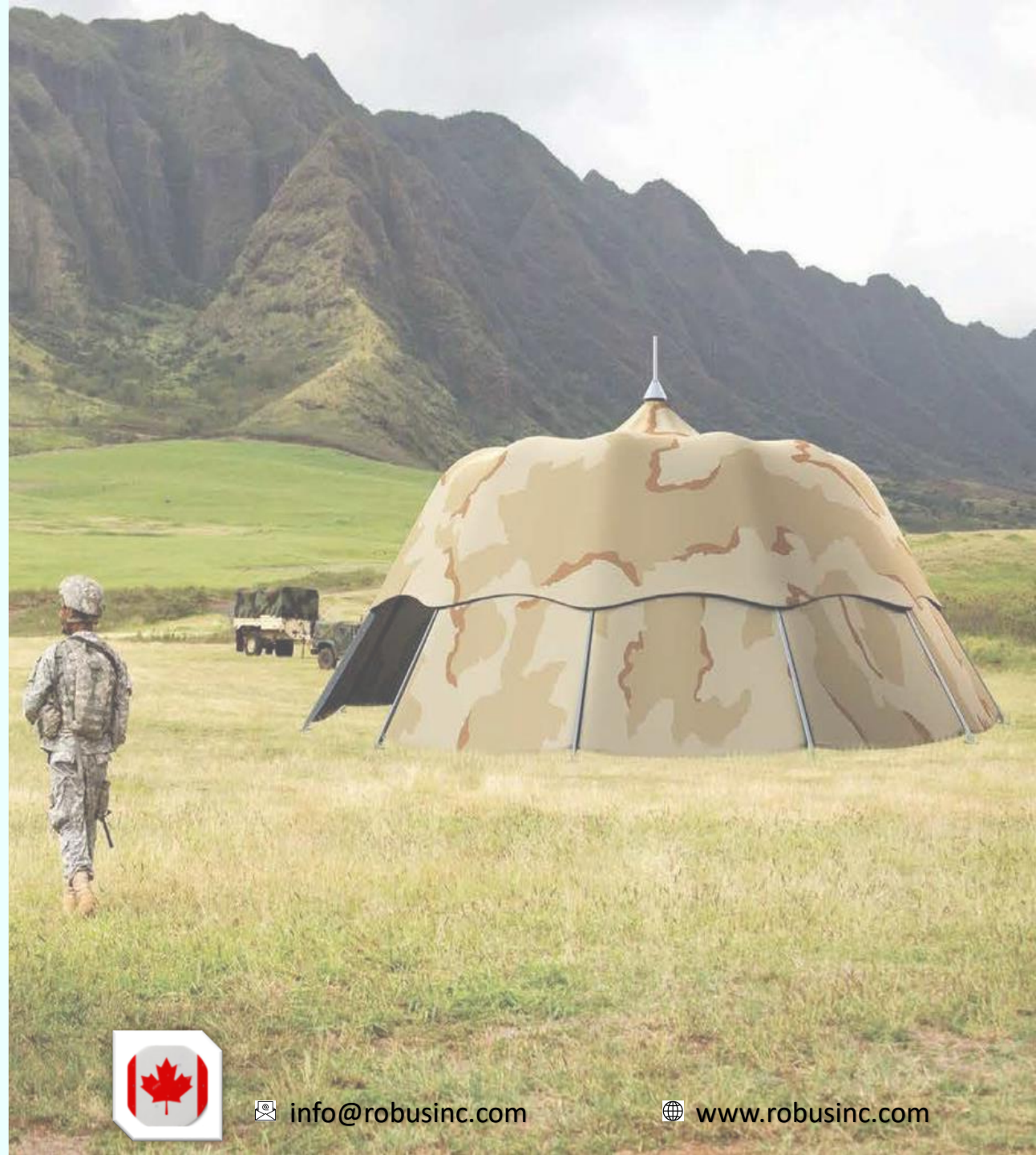

[info@robusingc.com](mailto:info@robusingc.com)

[www.robusingc.com](http://www.robusingc.com)

# 20M ROBUS SHELTER SYSTEM WITH BLACKHAWK

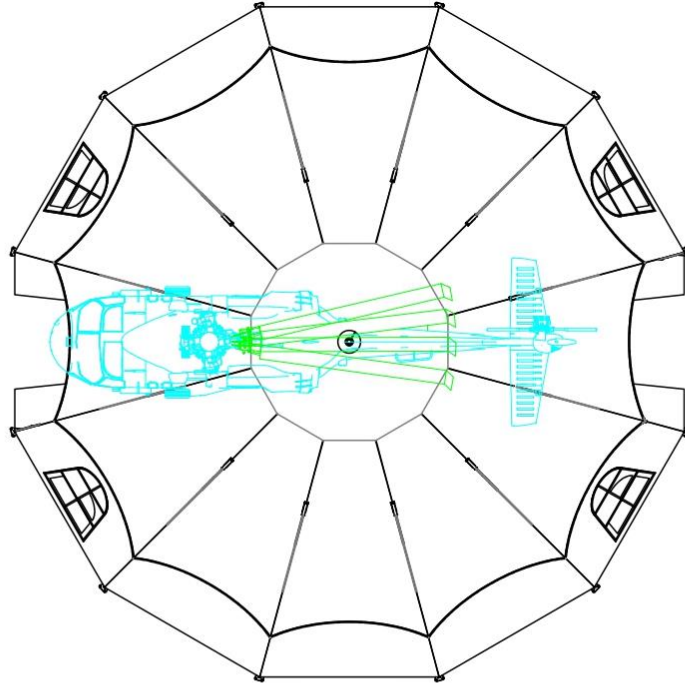

TOP VIEW

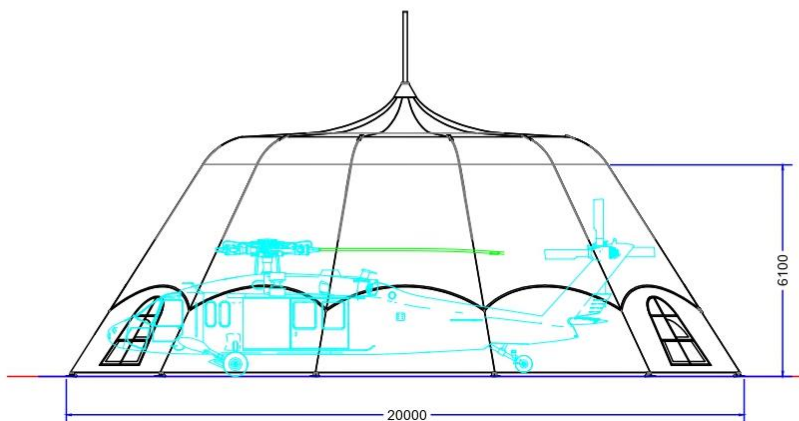
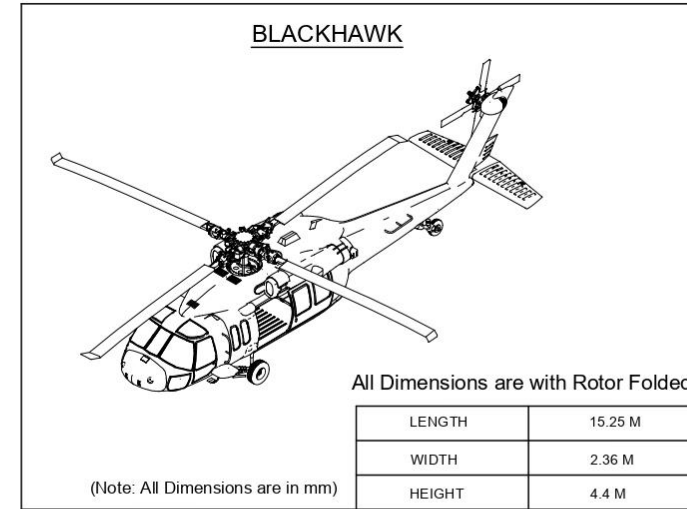

SIDE VIEW

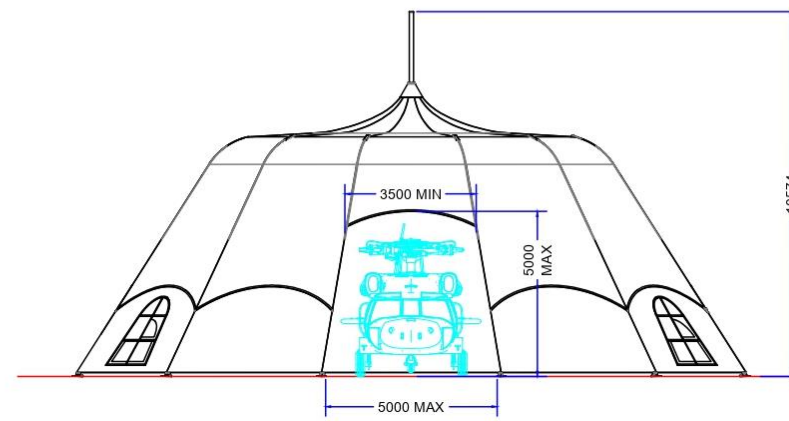

FRONT VIEW



# 20M ROBUS SHELTER SYSTEM WITH BLACKHAWK



# 20M ROBUS SHELTER SYSTEM WITH BLACKHAWK







## 20M ROBUS SHELTER SYSTEM – TECHNICAL SPECIFICATION

### DIAMETER SIZES

- 20 M
- 65.6 Ft

### CIRCULAR GROUND AREA

- 314 Sq. M
- 3380 Sq. Ft

### DEPLOYMENT TIME

- 05-10 (MINUTES)

### PERSONNEL

- 2 PERSONS







THANK YOU

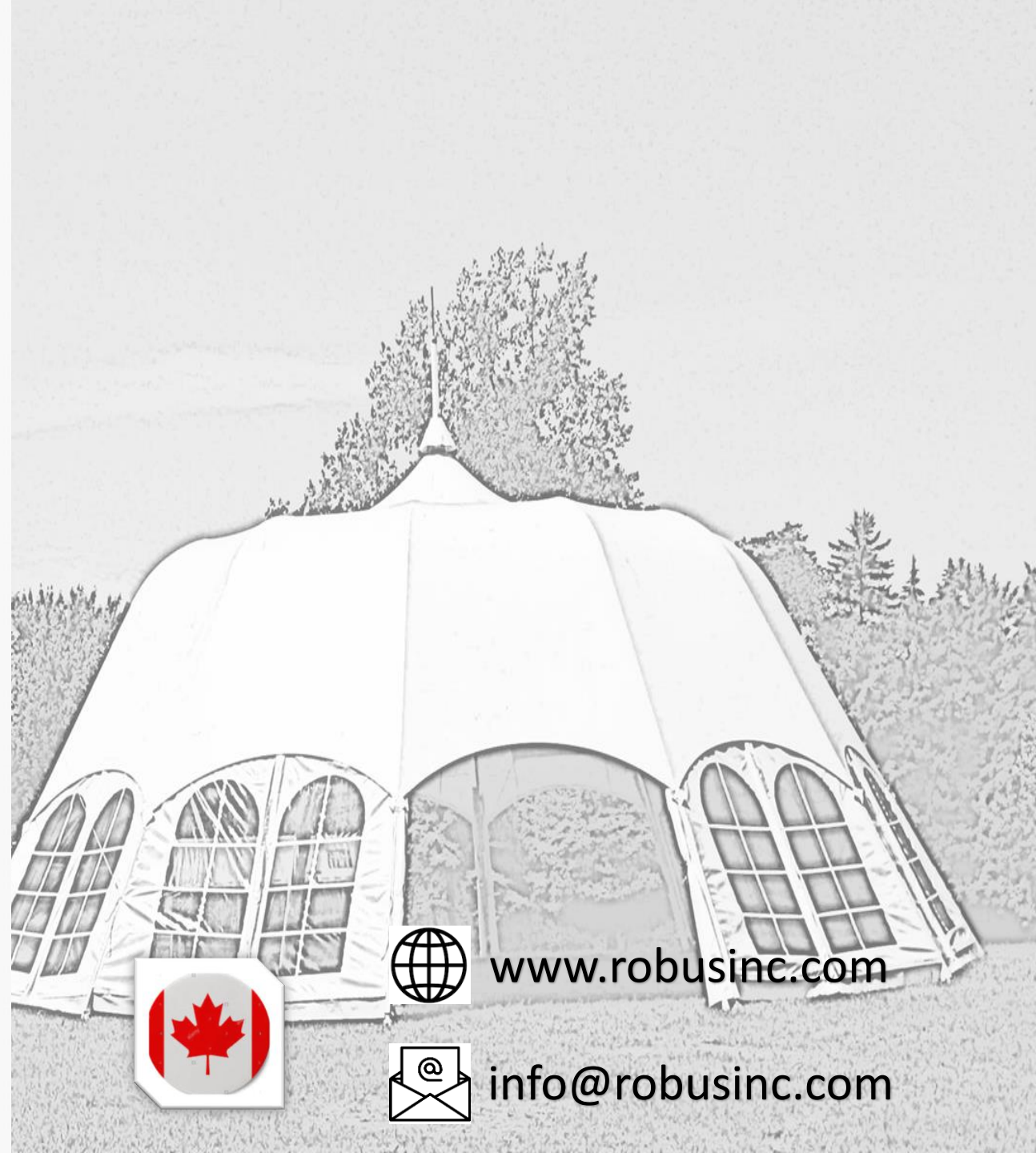

[www.robusinc.com](http://www.robusinc.com)



[info@robusinc.com](mailto:info@robusinc.com)



# ROBUS SANITISATION SYSTEM

MOBILE MEDICAL RE-DEPLOYABLE SYSTEM



## CANADA

1200 McGill College Avenue  
Suite 1100, Montreal  
Quebec, H3B 4G7, Canada  
Tel: +1 514 228 0451

## LONDON

Berkeley Square House  
Berkeley Square, London  
W1J 6BD, United Kingdom  
Tel: +44 203 995 4776

## NEW YORK

One Rockefeller Plaza  
10th Floor, New York  
NY 10020, United States  
Tel: +1 646 722 2876

 [info@robustinc.com](mailto:info@robustinc.com)

 [www.robustinc.com](http://www.robustinc.com)



**HIGH PERFORMANCE SOLUTIONS IN EVERY ENVIRONMENT**

# ROBUS SANITISATION SYSTEM

- MEDICAL RESPONSE • RAPID DEPLOYMENT • FULL LED LIGHTING
- ELECTRICAL SOCKETS ALL ROUND • POWERED BY ON BOARD GENERATOR
- POWERED BY MAINS ELECTRIC OR ON BOARD GENERATOR

ROBUS in response to the current situation have urgently manufactured mobile systems to assist the U.A.E. Health Authorities

The ROBUS shelter provides a fast dry safe environment creating immediate medical space for all types of purposes such as beds screening first aid posts storage areas and can be finished internally to any required specifications including beds tables chairs

Able to withstand all kinds of weather withstanding storms of up to 120kh the aluminium superstructure allows up to 3 tons of hanging for medical supplies equipment and provisions

## HIGH PERFORMANCE MEDICAL SOLUTIONS FOR ADDITIONAL SPACE

In response to the current situation Robus have introduced mobile isolation shelter systems for use in the grounds of hospitals and Medical Centers for the benefit of the U.A.E.



**ROBUS  
SANITISATION SYSTEM**  
MOBILE MEDICAL RE-DEPLOYABLE SYSTEM

# ROBUS SANITISATION SYSTEM



**HIGH PERFORMANCE SOLUTIONS IN EVERY ENVIRONMENT**



**ROBUS  
SANITISATION SYSTEM**  
MOBILE MEDICAL RE-DEPLOYABLE SYSTEM

# ROBUS SANITISATION SYSTEM



**HIGH PERFORMANCE SOLUTIONS IN EVERY ENVIRONMENT**



**ROBUS  
SANITISATION SYSTEM**  
MOBILE MEDICAL RE-DEPLOYABLE SYSTEM

# ROBUS SANITISATION SYSTEM



**HIGH PERFORMANCE SOLUTIONS IN EVERY ENVIRONMENT**





**ROBUS  
SANITISATION SYSTEM**  
MOBILE MEDICAL RE-DEPLOYABLE SYSTEM

# ROBUS SANITISATION SYSTEM

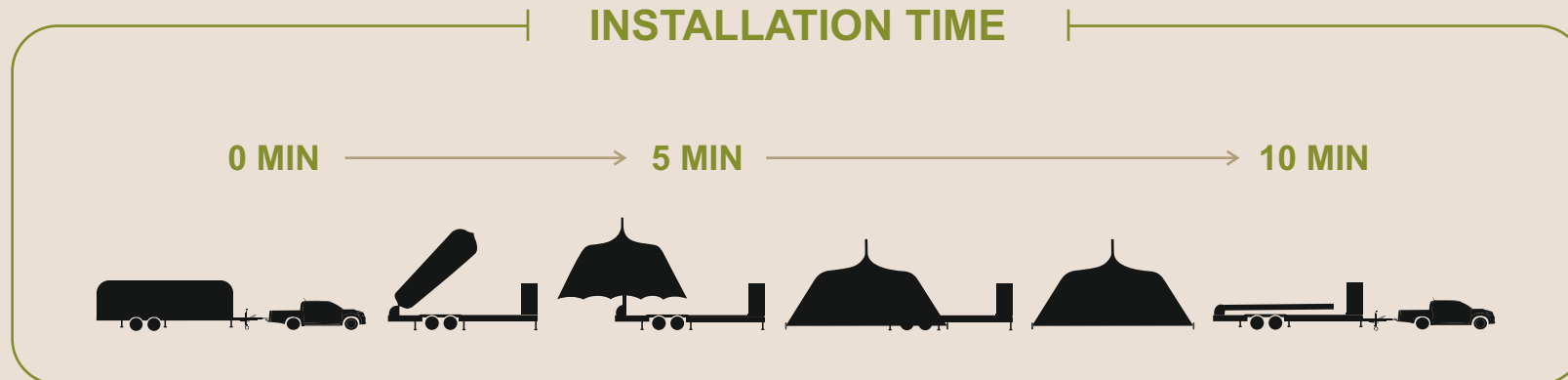
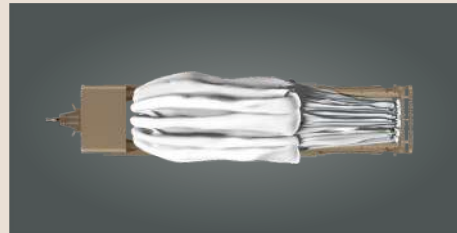

MEDICAL-SECURITY- FIRST AID POSTS READY FOR OPERATION IN MINUTES



**HIGH PERFORMANCE SOLUTIONS IN EVERY ENVIRONMENT**



# ROBUS SANITISATION SYSTEM

MOBILE AIRPORT RE-DEPLOYABLE SYSTEM  
ROBUS MEDICAL DIVISION



## CANADA

1200 McGill College Avenue  
Suite 1100, Montreal  
Quebec, H3B 4G7, Canada  
Tel: +1 514 228 0451

## LONDON

Berkeley Square House  
Berkeley Square, London  
W1J 6BD, United Kingdom  
Tel: +44 203 995 4776

## NEW YORK

One Rockefeller Plaza  
10th Floor, New York  
NY 10020, United States  
Tel: +1 646 722 2876

 [info@robusiness.com](mailto:info@robusiness.com)

 [www.robusiness.com](http://www.robusiness.com)



**HIGH PERFORMANCE SOLUTIONS IN EVERY ENVIRONMENT**



**ROBUS  
SANITISATION SYSTEM**  
MOBILE AIRPORT RE-DEPLOYABLE SYSTEM  
ROBUS MEDICAL DIVISION

# ROBUS SANITISATION SYSTEM



**HIGH PERFORMANCE SOLUTIONS IN EVERY ENVIRONMENT**



**ROBUS  
SANITISATION SYSTEM**  
MOBILE AIRPORT RE-DEPLOYABLE SYSTEM  
ROBUS MEDICAL DIVISION

# ROBUS SANITISATION SYSTEM



**HIGH PERFORMANCE SOLUTIONS IN EVERY ENVIRONMENT**



**ROBUS  
SANITISATION SYSTEM**  
MOBILE AIRPORT RE-DEPLOYABLE SYSTEM  
ROBUS MEDICAL DIVISION

# ROBUS SANITISATION SYSTEM



**HIGH PERFORMANCE SOLUTIONS IN EVERY ENVIRONMENT**



**ROBUS  
SANITISATION SYSTEM**  
MOBILE AIRPORT RE-DEPLOYABLE SYSTEM  
ROBUS MEDICAL DIVISION

# ROBUS SANITISATION SYSTEM



**HIGH PERFORMANCE SOLUTIONS IN EVERY ENVIRONMENT**



**ROBUS  
SANITISATION SYSTEM**  
MOBILE AIRPORT RE-DEPLOYABLE SYSTEM  
ROBUS MEDICAL DIVISION

# ROBUS SANITISATION SYSTEM



**HIGH PERFORMANCE SOLUTIONS IN EVERY ENVIRONMENT**



**ROBUS  
SANITISATION SYSTEM**  
MOBILE AIRPORT RE-DEPLOYABLE SYSTEM  
ROBUS MEDICAL DIVISION

# ROBUS SANITISATION SYSTEM



**HIGH PERFORMANCE SOLUTIONS IN EVERY ENVIRONMENT**